

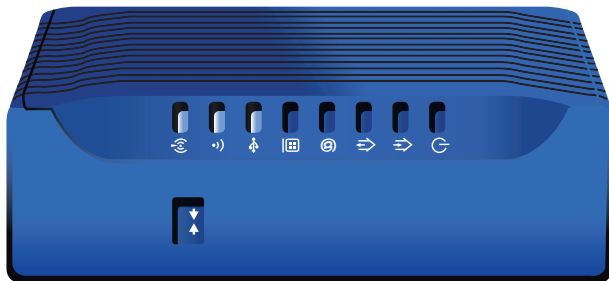

comwave[®]

Internet



Installation Guide

Package Contents

Package Contents



COMWAVE CGN-RES
INTERNET MODEM







ETHERNET CABLE

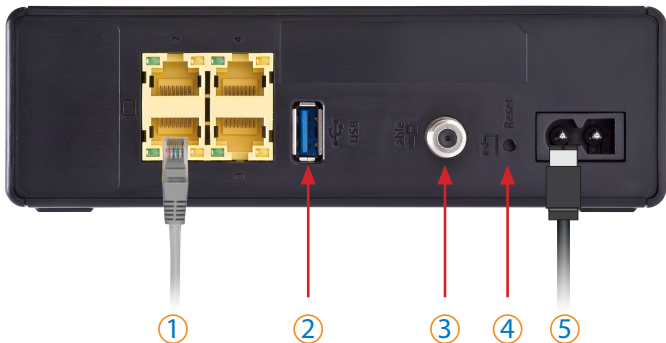

POWER ADAPTER
OUTPUT: 12V



- ① LAN  Connect to your computer using the Ethernet Cable supplied.
(1 to 4)
- ② USB  Currently not supported.
- ③ Cable  Connect Comwave Internet Modem to your internet line.
- ④ Reset  Reset to the original factory settings.
- ⑤ Power Adapter Connect to a power source using the Power Adapter supplied.

LED Light Indicators





Please follow the step by step instructions on the following pages.

Upon completion of set up, the following LED lights should be on. The lights may be green or blue.

Note:  Indicator will only be lit when WiFi is enabled.

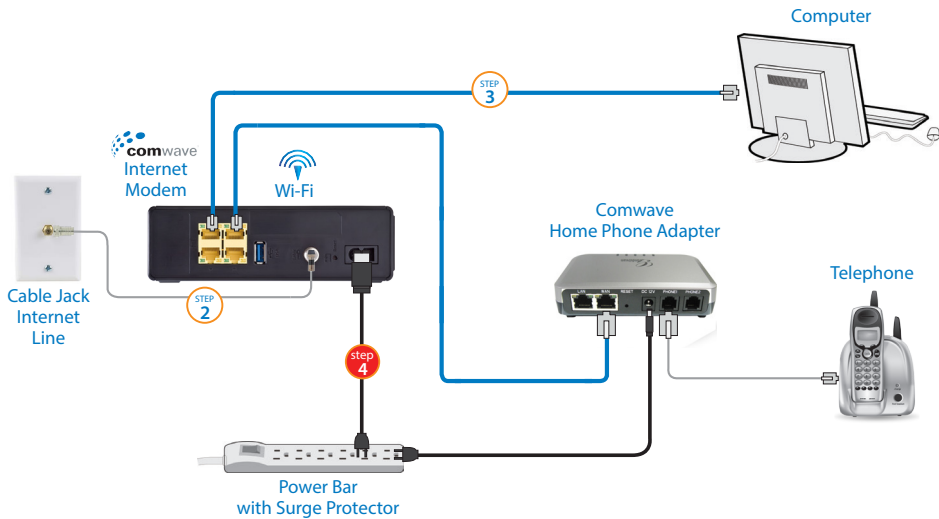
Installation



Continue to 



step 1 To begin installation, shut down your computer.

step 2 Connect the Comwave Internet Modem using a standard cable wire (not supplied) to the wall jack.

step 3 Connect the supplied Ethernet Cable from the LAN port of the Comwave Internet Modem to your computer.

step 4 (For Home Phone) Connect the supplied Ethernet cable from the LAN port of your Comwave Internet Modem to the WAN port of the Home Phone Adapter.

step 5 Connect the Comwave Internet Modem to a power outlet.
Note: Wait until the **LED Light Indicators** on your Comwave Internet Modem indicate that the Modem is operational. This may take up to 5 minutes.

step 6 (For Home Phone) Connect a telephone to the PHONE 1 port on the Home Phone Adapter. Then connect power to the Home Phone Adapter and wait 5 minutes for dial tone.
DO NOT DISCONNECT POWER as it may damage the Home Phone Adapter.

step 7 Start your computer.

step 8 You should be able to browse the Internet instantly.

Can't access the Internet?

- 1 Unplug the power to your Comwave Internet Modem, Home Phone Adapter and shut down your computer.
- 2 Wait 30 seconds and then plug your Comwave Internet Modem's Power Cord back into the power outlet.
- 3 Wait until the LED Light Indicators on your Comwave Internet Modem indicate that the Modem is operational. This may take up to 5 minutes.
- 4 Start your computer and Home Phone Adapter.
- 5 Open your browser and start surfing the Internet.
- 6 Still unable to surf the Internet? Call us at 1-866-210-9149.

We'll get you back
up online!

Wi-Fi Settings

CAUTION

Your Comwave Internet Modem is already Wi-Fi enabled by Comwave. We **do not** recommend making any changes to the default settings. Only **advanced** users should attempt to make changes or shut off the Wi-Fi settings by following the steps below.

step 1

Ensure your Computer is directly connected to your Comwave Internet Modem before you begin.

step 2

Open your Internet browser and type `http://192.168.0.1` in the address bar.

step 3

Enter your **Username:** "cusadmin" and **Password:** "password". Click **LOGIN** to proceed into the Comwave Internet Modem System Info screen.



HitronTechnologies

Username:

Password:

LOGIN



Language: English Log Out

System Info Initialization CM Status Password



Setup Wizard



Status



WAN/LAN



Firewall



Parental Control



Wireless

This menu displays general information

Device Information

HW version 1A
SW version 3.1.6.1
Serial Number 2441230F4990
RF MAC BC 14 01 24 52 00
WLAN ID 0.0.0.0
System Update 000 days 00h:10m:50s
System Time ---:--:--

Wireless Information

WiFi Status	ON	
SSID Setting	SSID Name	Security Mode
Primary SSID	CGN-SSID0	WPA2/WPA-Personal Mixed

Security Information

Firewall Status ON
Security Level Medium
Intrusion Alert ON

step 4

Click **Wireless** in the left menu.

step 5

Click **Basic Settings** in the top menu to

- i. Disable your Wi-Fi – Primary Network
- ii. Change your SSID network name

step 6

Click **WPS & Security** in the top menu to

- iii. Change your Security Type
- iv. Choose your Wireless Key

step 7

Click **Apply**.

Hitron Technologies

Language: English Log Out

Basic Settings WPS & Security Access Control

Setup Wizard
Status
WAN/LAN
Firewall
Parental Control
Wireless

Wireless Basic Settings

Wireless ON/OFF: ENABLE
Wireless Mode: 11B/G/N Mixed
Channel: auto
WPS ON/OFF: OFF
Security Mode: WPA2/WPA Mixed Mode

SSID setting	SSID name	hidden	in-service	WMM Mode
Primary SSID	CGN-52D0	<input type="checkbox"/>	<input checked="" type="checkbox"/>	<input type="checkbox"/>

Apply Cancel Help

Hitron Technologies

Language: English Log Out

Basic Settings WPS & Security Access Control

Setup Wizard
Status
WAN/LAN
Firewall
Parental Control
Wireless

Wi-Fi Protected Setup

WPS ON/OFF: DISABLE

Wireless Security

SSID: CGN-52D0
Security Mode: WPA2/WPA-Personal Mixed

WPA Setting

Cipher Type: TKIP and AES
Pre-shared Key: password

Apply Cancel Help

Watch our step by step
videos at
www.comwave.net/videos



CGN-RES

Need more help?
1-866-210-9149