



**comwave**<sup>®</sup>

Internet



**Installation Guide CGN-RES**

# Package Contents

## Package Contents



COMWAVE CGN-RES  
INTERNET MODEM







ETHERNET CABLE

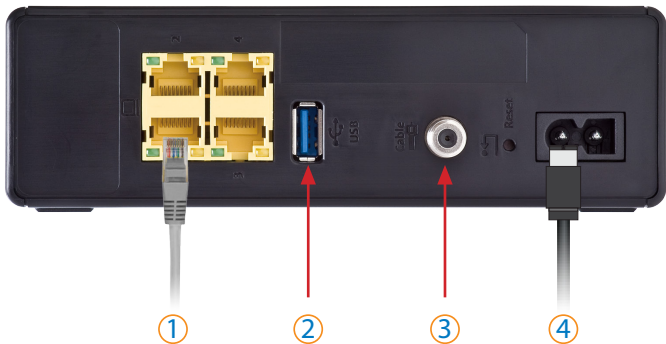

POWER ADAPTER  
OUTPUT: 12V



- ① **LAN**  Connect to your computer using the Ethernet Cable supplied. (1 to 4)
- ② **USB**  Currently not supported.
- ③ **Cable**  Connect Comwave Internet Modem to your cable connection.
- ④ **Power**  Connect to a power source using the Power Adapter supplied.

# LED Light Indicators



Please follow the step by step instructions on the following pages.

Power

Upon completion of set up, the following LED lights should be on. The lights may be green or blue.

Online

**Note:**  Indicator will only be lit when Wi-Fi is enabled.

# Installation

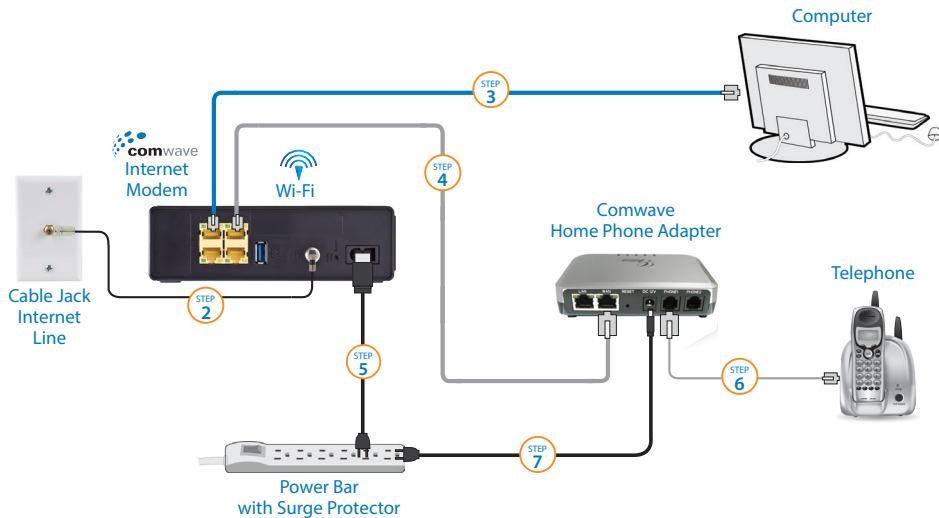

Continue to

STEP 1

STEP 1

To begin installation, shut down your computer.



STEP 2

Connect the Comwave Internet Modem using the cable connection.

STEP 3

Connect the supplied Ethernet Cable from the LAN port of the Comwave Internet Modem to your computer.

STEP 4

**(For Home Phone)** Connect the supplied Ethernet cable from the LAN port of your Comwave Internet Modem to the WAN port of the Home Phone Adapter.

STEP 5

Connect the Comwave Internet Modem to a power outlet.  
**Note:** Wait until the **LED Light Indicators** on your Comwave Internet Modem indicate that the Modem is operational. This may take up to 5 minutes.

STEP 6

**(For Home Phone)** Connect a telephone to the PHONE 1 port on the Home Phone Adapter.

STEP 7

Connect the Comwave Home Phone Adapter to a power outlet and wait 5 minutes for a dial tone.  
**DO NOT DISCONNECT POWER** as it may damage the Home Phone Adapter.

STEP 8

Start your computer. You should be able to browse the Internet instantly.

STEP 9

Test your phone line, you should have a dial tone and be able to make calls.

## Can't access the Internet?

- 1 Unplug the power to your Comwave Internet Modem, Home Phone Adapter and shut down your computer.
- 2 Wait 30 seconds and then plug your Comwave Internet Modem's Power Cord back into the power outlet.
- 3 Wait until the LED Light Indicators on your Comwave Internet Modem indicate the Modem is operational. This may take up to 5 minutes.
- 4 Start your computer and plug in the Home Phone Adaptor into a power outlet.
- 5 Open your browser and start surfing the Internet. Check for a dial tone.

We'll get you back up online!

# Wi-Fi Settings

## CAUTION

Your Comwave Internet Modem is already Wi-Fi enabled by Comwave. We **do not** recommend making any changes to the default settings. Only **advanced** users should attempt to make changes or shut off the Wi-Fi settings by following the steps below.

STEP 1

To log into your Wi-Fi, use the default login information found on the "STOP" sticker on the back of your modem.

STEP 2

To change your default Wi-Fi Username and Password make sure your computer is connected via the Ethernet Cable to your Comwave Internet Modem.



HitronTechnologies

Username:

Password:

LOGIN

STEP 4



Language: English Log Out

System Info Initialization CM Status Password



Setup Wizard



Status



WAN/LAN



Firewall



Parental Control



Wireless

STEP 5

This menu displays general information

### Device Information

HW version 1A  
SW version 3.1.6.1  
Serial Number 2441230F4990  
RF MAC BC 14 01 24 52 00  
WAN IP 0.0.0.0  
System Update 000 days 00h:10m:50s  
System Time ---:--:--:--:--:--:--

### Wireless Information

WiFi Status	ON	
SSID Setting	SSID Name	Security Mode
Primary SSID	CGN-SSID0	WPA2/WPA-Personal Mixed

### Security Information

Firewall Status ON  
Security Level Medium  
Intrusion Alert ON

**STEP 3** Open your Internet browser and type `http://192.168.0.1` in the address bar.

**STEP 4** Enter your **Username: "cusadmin"** and **Password: "password"**. Click **LOGIN** to proceed into the Comwave Internet Modem System Info screen.

**STEP 5** Click **Wireless** in the left menu.

**STEP 6** Click **Basic Settings** in the top menu to  
i. Disable your Wireless  
ii. Change your SSID network name

**STEP 7** Click **WPS & Security** in the top menu to  
iii. Change your Security Mode  
iv. Choose your Wireless Key

**STEP 8** Click **Apply**.

**STEP 6**

Language: English Log Out

Basic Settings WPS & Security Access Control

Setup Wizard  
Status  
WAN/LAN  
Firewall  
Parental Control  
Wireless

Wireless Basic Settings

Wireless ON/OFF: ENABLE  
Wireless Mode: 11B/G/N Mixed  
Channel: auto  
WPS ON/OFF: OFF  
Security Mode: WPA2/WPA Mixed Mode

SSID setting	SSID name	hidden	in-service	WMM Mode
Primary SSID	CGN-52D0	<input type="checkbox"/>	<input type="checkbox"/>	<input type="checkbox"/>

Apply Cancel Help

**STEP 7**

Language: English Log Out

Basic Settings WPS & Security Access Control

Setup Wizard  
Status  
WAN/LAN  
Firewall  
Parental Control  
Wireless

Wi-Fi Protected Setup

WPS ON/OFF: DISABLE

Wireless Security

SSID: CGN-52D0  
Security Mode: WPA2/WPA-Personal Mixed

WPA Setting

Cipher Ivse: TKIP and AES  
Pre-shared Key: password

Apply Cancel Help



For further assistance, please call  
416-663-9600

CGN-RES